



12-month Flip Calendar

Materials

- 14 sheets of card stock
- X-ACTO knife
- Cutting mat
- Metal-edged ruler
- Butter knife or scoring tool
- Spoon
- Pencil
- Scrap paper
- 6 medium-sized binder clips

Instructions: trimming and folding

1. Print the calendar pages (pages 6-18) onto card stock. Set aside to dry completely.
2. Cut out the calendar pages with an X-ACTO knife, using the ruler and crop marks as a guide. See illustration A.
3. Stack the pages in order with the cover on top. Set aside for later.
4. Print the calendar stand page (page 5). Set aside to dry completely.
5. Place the calendar stand page with the art side down on your work surface, and place the ruler horizontally across the page so that the 0" mark is at the left edge. See illustration B.
6. With a pencil, mark the paper at the 4-1/2", 5-1/2", and 6-1/2" measurements.
7. Slide the ruler down the paper about half-way down the page (keeping the 0" mark aligned with the left edge) and repeat step 6.
8. Turn the ruler to the vertical position, and line up the two 4-1/2" marks. Run a butter knife or scoring tool along the ruler, using medium pressure, to create an indentation (score) on the paper.
9. Repeat step 8 for the 5-1/2" and 6-1/2" marks.
10. Mountain fold the center score line and valley fold the two outer score lines. See illustration C.
11. Using the back of a spoon, press folds firmly to crease.
12. Place the calendar stand (folded edge at the bottom, laying flat) on top of the pile of trimmed calendar pages. See illustration D.
13. Divide the pile of calendar pages into two stacks. (One will be the calendar stand through April and the other will be May through December.)





i n v e n t

12-month Flip Calendar (continued)

14. To protect your calendar from being dented, wrap a small piece of scrap paper around the edge of each stack, align the pages, and secure with binder clips on top of the scrap paper. Label the stack with the calendar stand "stack A" and the other "stack B." See illustration E.

Binding and cutting: (at a copy shop)

1. Take the two stacks to your local copy store and ask for 1/2" diameter spiral binding.
2. The copy store will drill the calendar.
3. Unclamp the two stacks, placing stack A on top and have the pages spiral bound.
4. The calendar is ready to use!

Take it one step further! You can make your desk calendar more interactive by making a three-piece desk calendar. See illustration F.

1. Once the calendar pages have been drilled, unclamp the binder clips from stack A and remove both the cover and the stand. Set them aside for later. Re-clamp the stack with the scrap paper.
2. Add two more clamps to each stack, equally spacing them along the bottom. See illustration G.
3. Label the stacks again (1, 2 and 3) above each binder clip beginning with the left clip. This will help keep the pages organized once they are cut.
4. Have the copy center cut each stack vertically into three equal parts. See illustration H.
5. Keeping the binder clips in place, organize the six stacks into piles, placing stack A1 on top of B1 and so on.
6. Place the cover on top of all of your stacks, and place the stand on top of the cover.
7. With help from the copy center (and a bit of patience), wind the spiral binding through all the pages and stacks.
8. The ultra-cool golf calendar is ready to use!

align ruler with edge of art and corresponding crop marks, then cut paper (when making these cuts, stay within the dotted lines so that you don't cut off the crop marks)

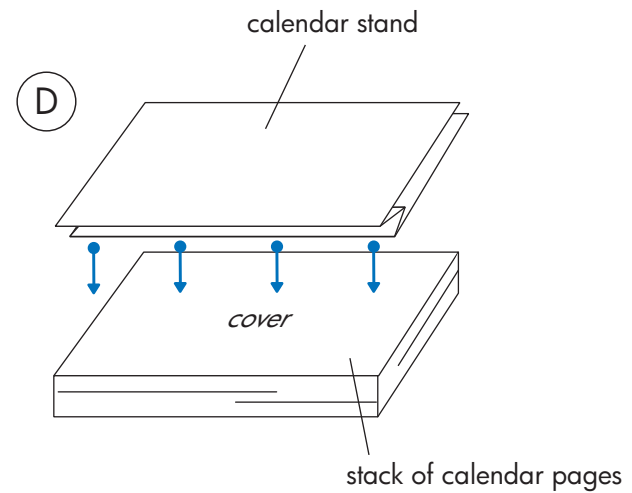
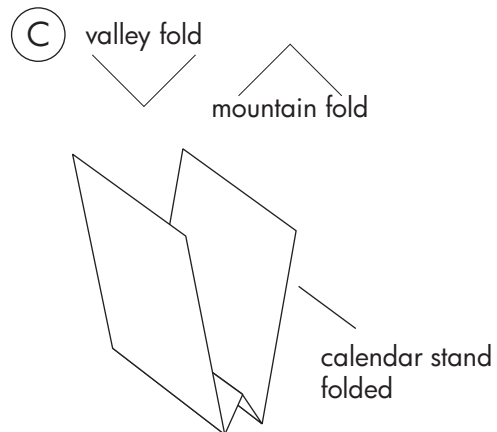
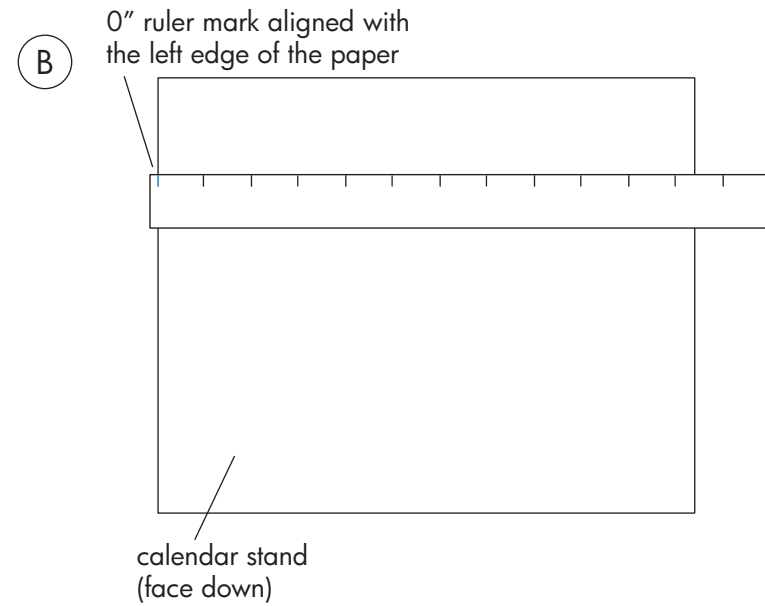
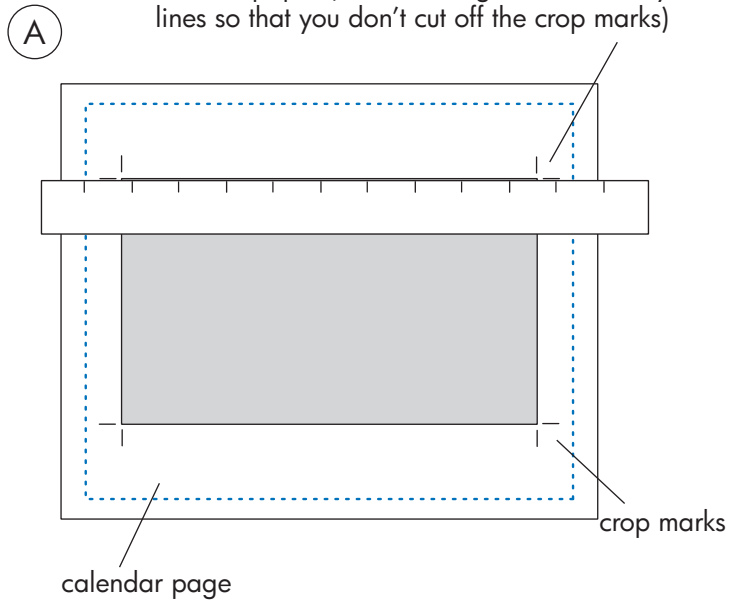

E

stack of calendar pages with cover and stand

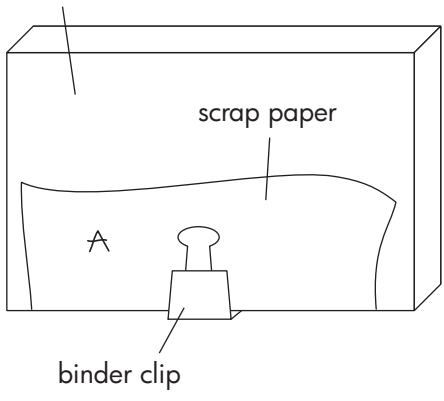

stack of remaining calendar pages

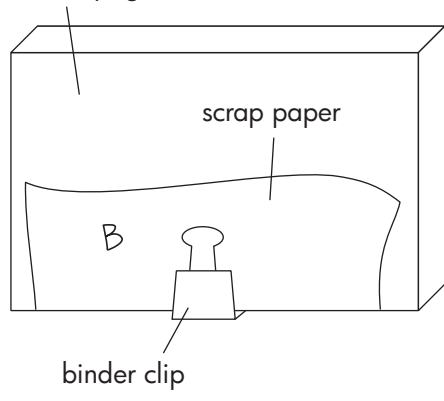

F

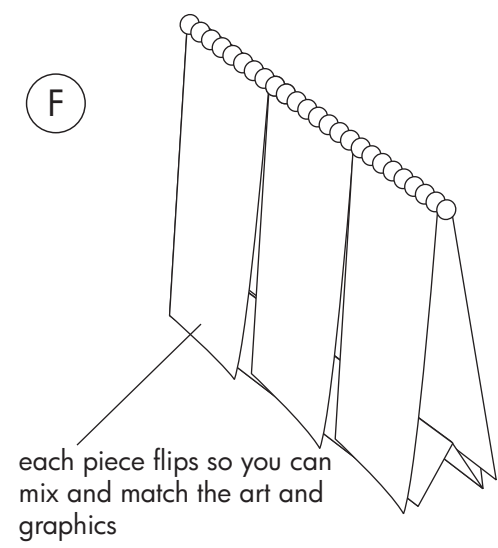

G

stack of calendar pages with cover and stand

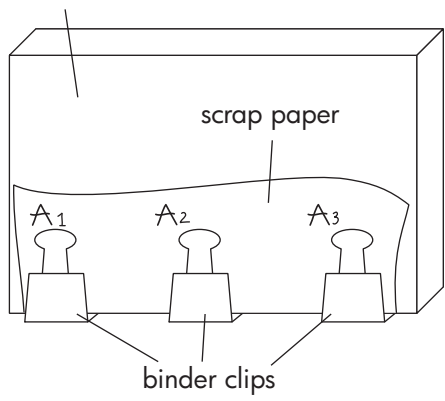

stack of remaining calendar pages

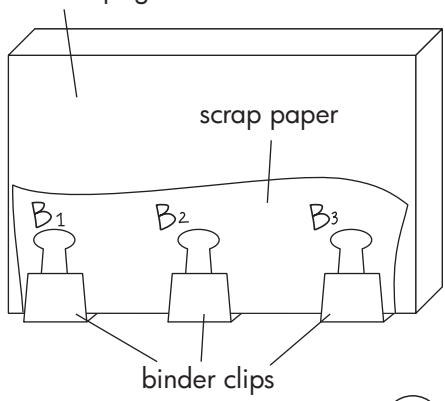

H

make cuts here

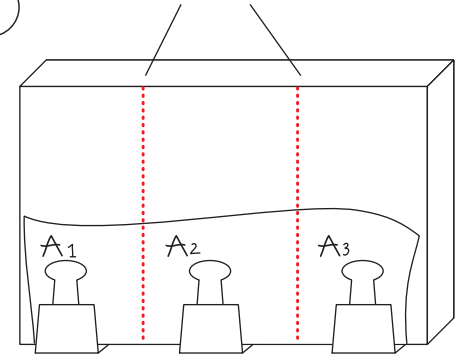

make cuts here

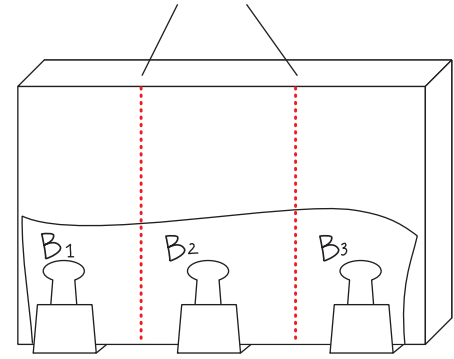

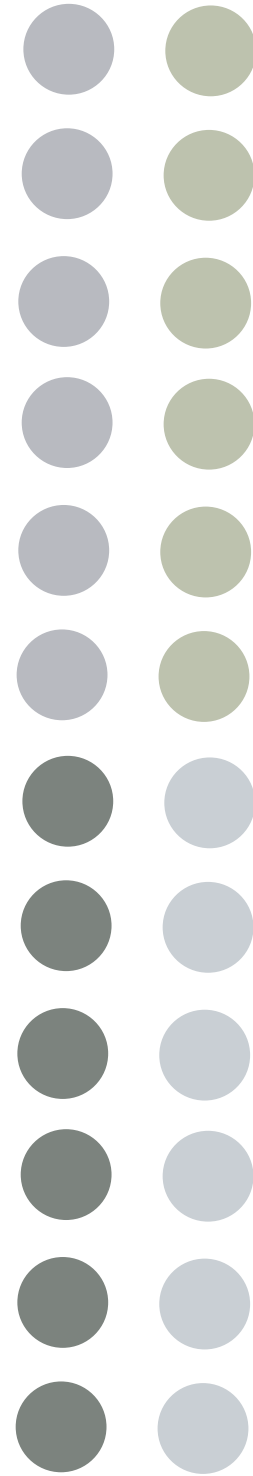
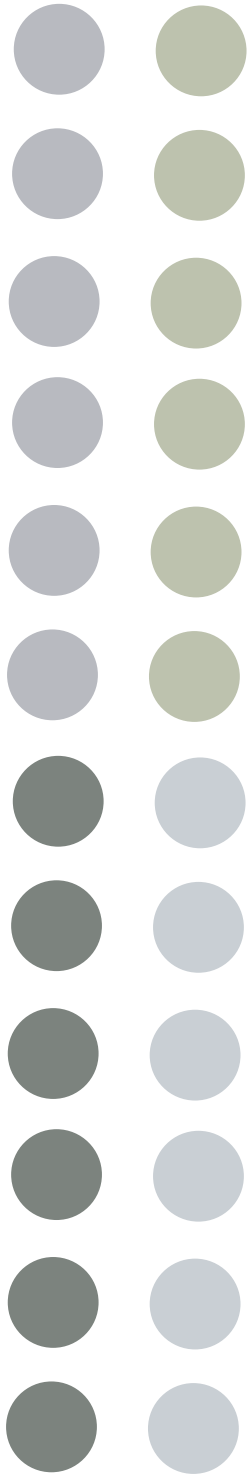

THE ART OF GOLF

A TWELVE-MONTH FLIP CALENDAR

january-december 2003

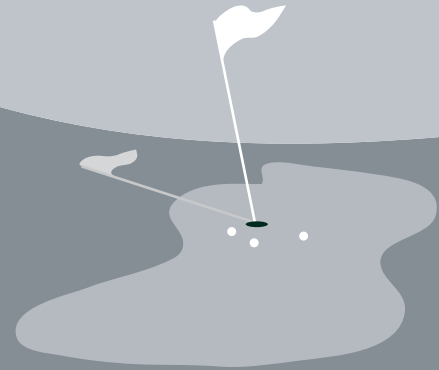

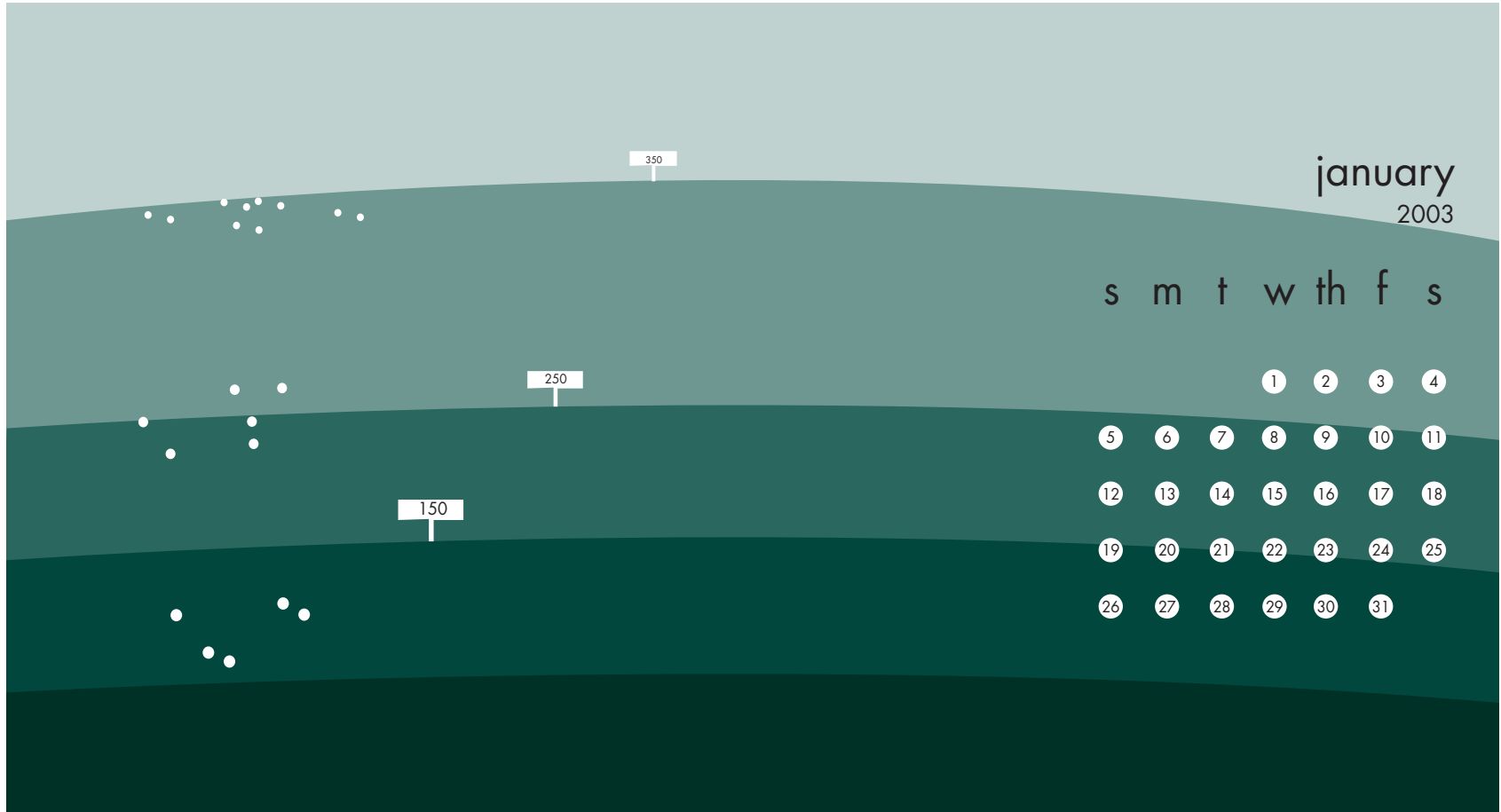

february
2003

s m t w th f s

						1
2	3	4	5	6	7	8
9	10	11	12	13	14	15
16	17	18	19	20	21	22
23	24	25	26	27	28	



*"Golf is a game whose aim it is to hit a very small ball into an even smaller hole with weapons singularly ill-designed for the purpose."
-Winston Churchill*

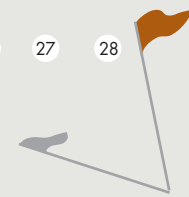

march
2003

s m t w th f s

						1
2	3	4	5	6	7	8
9	10	11	12	13	14	15
16	17	18	19	20	21	22
23	24	25	26	27	28	29
30	31					

grip it and rip it.

april
2003

*"The only shots you can be dead
sure of are those you've had already."
-Bryon Nelson*

s m t w th f s

		1	2	3	4	5
6	7	8	9	10	11	12
13	14	15	16	17	18	19
20	21	22	23	24	25	26
27	28	29	30			



*"Don't you just hate it when you try to think of something other than golf...and you can't?"
-Mike Purbeck*



may
2003

s	m	t	w	th	f	s
					1	2 3
4	5	6	7	8	9	10
11	12	13	14	15	16	17
18	19	20	21	22	23	24
25	26	27	28	29	30	31



june
2003

s m t w th f s

1	2	3	4	5	6	7
8	9	10	11	12	13	14
15	16	17	18	19	20	21
22	23	24	25	26	27	28
29	30					

150

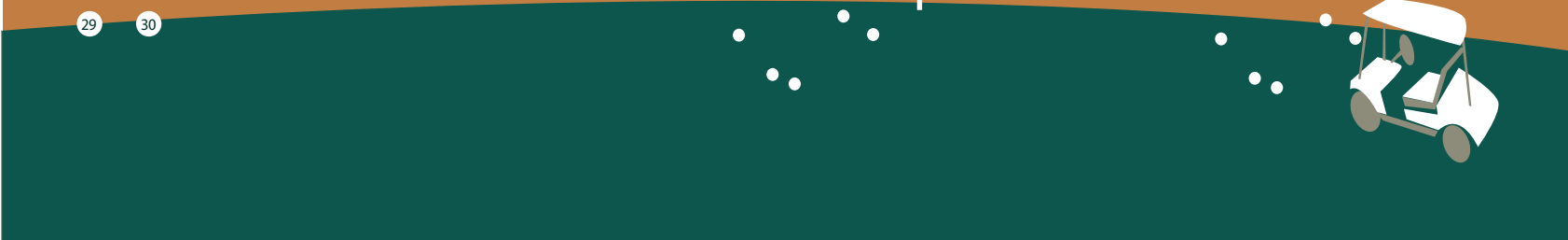

*"Competitive golf is played mainly on a five-and-a-half-inch course, the space between your ears."
- Bobby Jones*

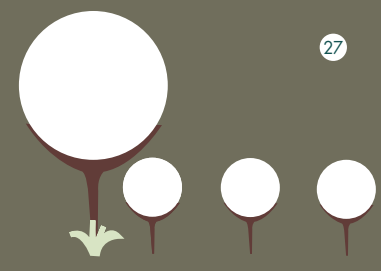
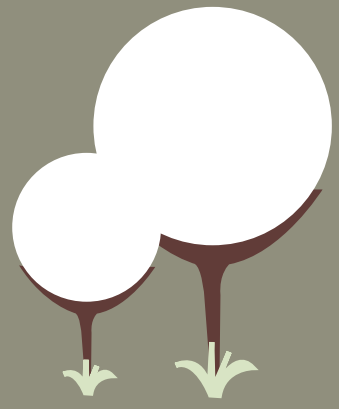

july
2003

s	m	t	w	th	f	s
		1	2	3	4	5
6	7	8	9	10	11	12
13	14	15	16	17	18	19
20	21	22	23	24	25	26
27	28	29	30	31		

See the ball, be the ball

august
2003

s	m	t	w	th	f	s
						1 2
3	4	5	6	7	8	9
10	11	12	13	14	15	16
17	18	19	20	21	22	23
24	25	26	27	28	29	30
31						

september
2003

s m t w th f s

	1	2	3	4	5	6
7	8	9	10	11	12	13
14	15	16	17	18	19	20
21	22	23	24	25	26	27
28	29	30				

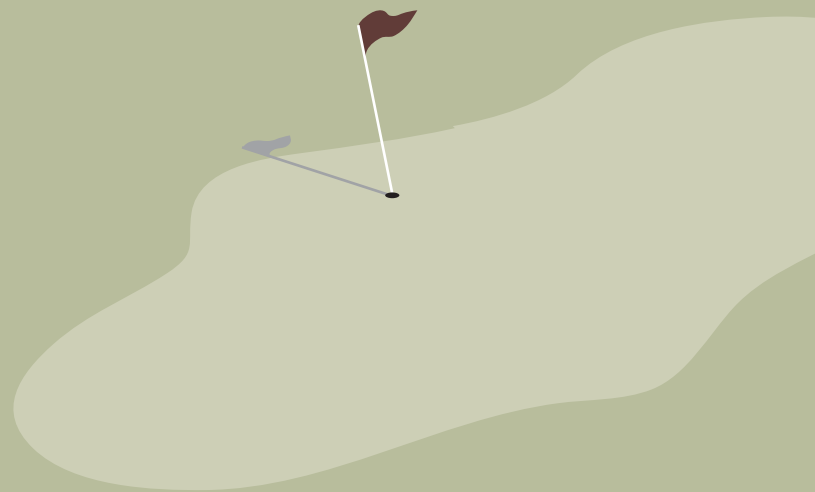

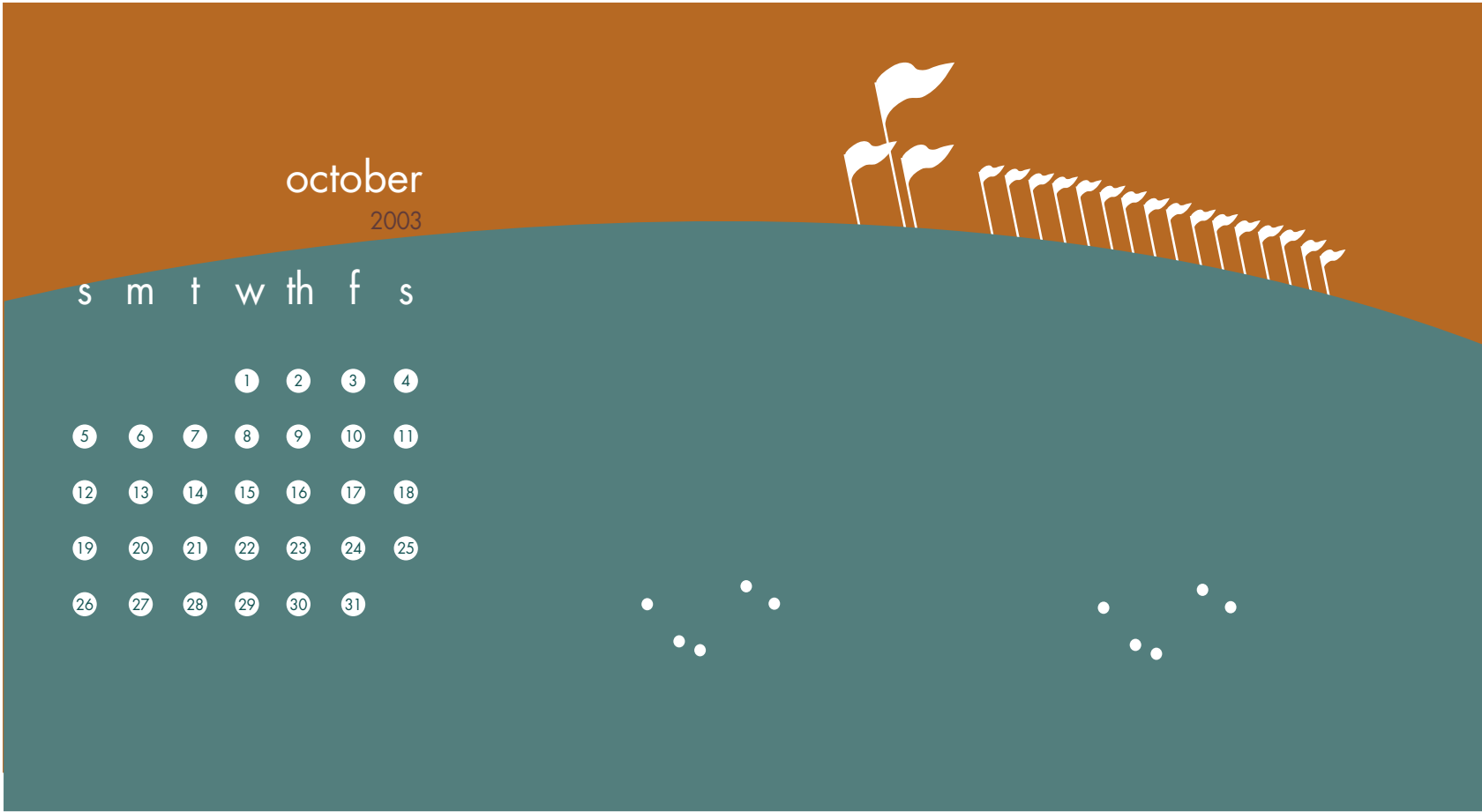

*"Golf is a game in which you yell 'fore,'
shoot six and write down five."
- Paul Harvey*

november
2003

s	m	t	w	th	f	s
						1
2	3	4	5	6	7	8
9	10	11	12	13	14	15
16	17	18	19	20	21	22
23	24	25	26	27	28	29
30						

december
2003

s m t w th f s

1	2	3	4	5	6	
7	8	9	10	11	12	13
14	15	16	17	18	19	20
21	22	23	24	25	26	27
28	29	30	31			



golf, more